

Sinexcel



SEC 240kW Series DC Fast Charger

User Manual

Issue 01

Date 2023-07-03

© Copyright 2023 Sinexcel. All rights reserved

Disclaimer

Sinexcel shall not be liable for any consequence caused by any of the following events:

- Warranty expiration of the warranty service.
- Failure to follow the operation instructions and safety precautions in this document, and the resulting equipment malfunction, component damage, personal injuries, or property damage are beyond the warranty scope.
- Installation or use in environments which are not specified in related international standards.
- Incorrect transportation, removal, storage, installation, or use.
- Unauthorized modifications to the product or software code or removal of the product.
- Device damage due to force majeure (such as lightning, earthquakes, fire, and storms)
- Unauthorized modifications to the product nameplate or serial number or product appearance.
- Storage conditions that do not meet the requirements specified in this document, unused products should be stored in packing cases and placed in a dry, (After delivery shall be started and test equipment operation status within 6 months, otherwise it shall be return to Sinexcel for aging test and payable the shipping cost.)
- Ensure that the area required for heat dissipation, Otherwise, the equipment may become faulty, and the resulting equipment malfunction, component damage, personal injuries, or property damage are beyond the warranty scope.
- Installation or use by unqualified personnel.
- This document content here is indicative only. If there is inconsistency between the content and the actual product, the actual product shall govern.

Notice

Before connecting the power supply, ensure that electrical connections are correct. Do not connect or disconnect power cables with power on.

Personnel who will operate the equipment, including operators, trained personnel, and professionals, should possess the local national required qualifications in special operations such as high-voltage operations, working at heights, and operations of special equipment.

Copyright © Shenzhen Sinexcel Electric Co.Ltd.2023. All rights reserved.

Foreword

Reader Object

This document (this guide) is primarily intended for the following engineers:

- Technical Support Engineer
- Maintenance Engineer
- Engineering installation team

Symbol Conventions

The following symbols may appear in this document and their description are as follows.













Symbol	Description
	<i>DANGER</i> Dangerous Voltage Dangerous voltages can cause death or injury.
	<i>WARNING</i> Hazard Warning May cause equipment damage and personal injury.
	<i>ATTENTION</i> Cause of Hazard Failure to comply may result in equipment damage or functional failure.

Table of Contents

1	Safety Precautions	1
1.1	Special symbols for warnings and dangers	1
1.2	Safety instructions for use	2
1.3	Safety instructions for operation	2
2	Product Overview	4
2.2	SEC series products model	4
2.3	Product types description	4
2.4	Product views	5
2.5	Product characteristics	6
2.6	Parameter table of product specifications	7
3	Installation instructions	9
3.1	Equipment dimensions	9
3.2	Equipment installation requirements	9
3.3	Construction of distribution cables	11
3.3.1	Layout requirements of distribution cables	11
3.3.2	Process requirements of distribution cables	12
3.3.3	Cable specifications for AC input (Recommended)	13
3.3.4	Internal wiring diagram of equipment	14
3.4	Inspection after installation	15
3.5	Special version	15
4	Operation interface	17
4.1	Charging process	17
4.1.1	Standby interface	17
4.1.2	Waiting for connector insertion interface	18
4.1.3	Connecting interface	19
4.1.4	Select charging mode interface	20
5	Simple troubleshooting	25
6	After-sales service	26

1 Safety Precautions

1.1 Special symbols for warnings and dangers

Symbol	Symbol word	Description
	<i>Danger</i>	Since some parts of this power system are under high voltage during operation, it is fatal for direct contact or indirect contact with these parts.
	<i>Danger</i>	Construction operation of high voltage lines may cause fire or electric shock. The wiring area and the area where the line passes through for AC cables must comply with National regulations and norms. Only personnel who are qualified to work with high DC and AC voltage are allowed to install and maintain the DC Charger.
	<i>Danger</i>	It is strictly forbidden to carry out live installation and maintenance work during thunderstorms.
	<i>Danger</i>	During operation, it is strictly forbidden to short-circuit the positive and negative of the DC Charger DC distribution or short-circuit any DC distribution polarity to Ground. The DC Charger is a high voltage DC power supply, and short circuits may cause damage to the DC Charger and personal safety hazards.
	<i>Warning</i>	Special tools must be used during various operations of high DC and AC voltages.
	<i>Warning</i>	During the handling of equipment by hand, it is necessary to wear protective gloves to prevent injuries caused by sharp objects.
	<i>Attention</i>	Make sure that the cable label is correct before the connection of cables.
	<i>Attention</i>	Signal cables should be kept away from power cables, protection from interference.
	<i>Attention</i>	Unable to relate to household' s environment.

1.2 Safety instructions for use

- The SEC (SEC Series DC fast charger) is an integrated charger that you can use to supply electricity to an EV either outdoor or indoor.
- The SEC is a high-power and high voltage electric power equipment, only qualified professionals are allowed to construction and maintenance.
- Follow local laws and regulations when installing, operating, or maintaining the equipment.
- Follow the procedures of installation, operation, and maintenance. And make sure this document and accessories provided by Sinexcel.
- Follow related safety standards on R&D, production, inspection, certification and filed at local.
- To ensure safety of humans and the equipment, pay attention to the safety symbols on the equipment and all the safety instructions in this document. Otherwise, the equipment may become hidden danger or faulty.
- When operating Sinexcel equipment has encountered any problems or faults, please consulting Sinexcel after-service center directly. If unauthorized found third party to maintenance under warranty, Sinexcel will not be liable.
- Installation conditions faraway from fire hazards or other dangerous environment.
- Make sure that the space around the equipment cannot get blocked.

1.3 Safety instructions for operation

- Before using for the first time you must read this document carefully, make sure that the equipment is installed and commissioned according to the instructions in the installation manual.
- Without Sinexcel permission, do not unauthorized modifications to the product or removal of the product. Sinexcel will not be liable for any consequence caused by the violation of the safety operation regulations and design, production, and usage standards.
- Do not touch the EV charging connector or vehicle inlet, keep it dry and clean.
- Do not use this product if the power cord or connector is frayed, has broken insulation, or shows any other signs of damage.
- In case of any abnormal condition, press the emergency button immediately, which will turn off all input and output to ensure safety.
If the emergency button is pressed, the system operator should be informed. The charging station shall not be restarted until the system operation technician reset the operation system.
- To make sure that no foreign bodies residues in EV charging connector or vehicle inlet.

- Do not connect or disconnect power cables with power on. When maintenance, turn off the power switch, ensure that electrical connections are correct, and putting warning board.
- Pay attention to the copper wire carries dangerous voltage of equipment, even all circuit breakers of the charger are disconnected.
- When maintenance, prepare the lighting. The interior of equipment no lighting.
- Connect protective earth wire (PE) before connecting neutral line and phase line.
- After installation or maintenance, ensure that door are lock correct.
- The adaptors or conversion adapters are not allowed be used.
- The extension cords are not allowed be used.

2 Product Overview

2.1 Short description

Function:

The SEC is an integrated DC fast charger that features high efficiency and flexible configured. It supports the CCS2 & JPN double connector charging at same time, The Charger used in centralized fast charging station, it adopts 20kW charging power module of Sinexcel, and meet the charging demand of larger capacity and high endurance electric on the market.

2.2 SEC series products model

SEC1000/240Y- HC -U

UL 240kW Integrated Charger with dual connectors

System type, used to distinguish application scenarios, here the default is U for UL certified models; this parameter will be replaced later if the model is certified for other regions
U: stands for UL certified model

Types of charging connectors to distinguish between different charging standards.

C: CCS1 charging connector for 200A
H: CCS1 charging connector for 300A
J: CHAdeMO charging connector for 125A

Charger Type
Y: Integrated charger

Rated output of the charger, the following options are available:
160/200/240kW

Nominal output voltage of the system, here 1000 Vdc is available

C: DC Charger

E: Electric Vehicle

S: Sinexcel

2.3 Product types description

Specification	Power distribution		Maximum current	
	Connector A	Connector B	Connector A	Connector B
SEC1000/160Y-C-U	CCS1:160kW	/	200A	/
SEC1000/160Y-CJ-U	CCS1:80kW or 160kW	JPN:62.5kW	200A	125A

Specification	Power distribution		Maximum current	
	Connector A	Connector B	Connector A	Connector B
SEC1000/160Y-CC-U	CCS1:80kW or 160kW	CCS1:80kW or 160kW	200A	200A
SEC1000/160Y-H-U	HCCS1:160kW	/	300A	/
SEC1000/160Y-HJ-U	HCCS1:80kW or 160kW	JPN:62.5kW	300A	125A
SEC1000/160Y-HH-U	HCCS1:80kW or 160kW	HCCS1:80kW or 160kW	300A	300A
SEC1000/200Y-C-U	CCS1:200kW	/	200A	/
SEC1000/200Y-CJ-U	CCS1:100kW or 200kW	JPN:62.5kW	200A	125A
SEC1000/200Y-CC-U	CCS1:100kW or 200kW	CCS1:100kW or 200kW	200A	200A
SEC1000/200Y-H-U	HCCS1:200kW	/	300A	/
SEC1000/200Y-HJ-U	HCCS1:100kW or 200kW	JPN:62.5kW	300A	125A
SEC1000/200Y-HH-U	HCCS1:100kW or 200kW	HCCS1:100kW or 200kW	300A	300A
SEC1000/240Y-C-U	CCS1:200kW	/	200A	/
SEC1000/240Y-CJ-U	CCS1:120kW or 200kW	JPN:62.5kW	200A	125A
SEC1000/240Y-CC-U	CCS1:120kW or 200kW	CCS1:120kW or 200kW	200A	200A
SEC1000/240Y-H-U	HCCS1:240kW	/	300A	/
SEC1000/240Y-HJ-U	HCCS1:120kW or 240kW	JPN:62.5kW	300A	125A
SEC1000/240Y-HH-U	HCCS1:120kW or 240kW	HCCS1:120kW or 240kW	300A	300A

2.4 Product views

Outside view of the SEC series DC fast charger

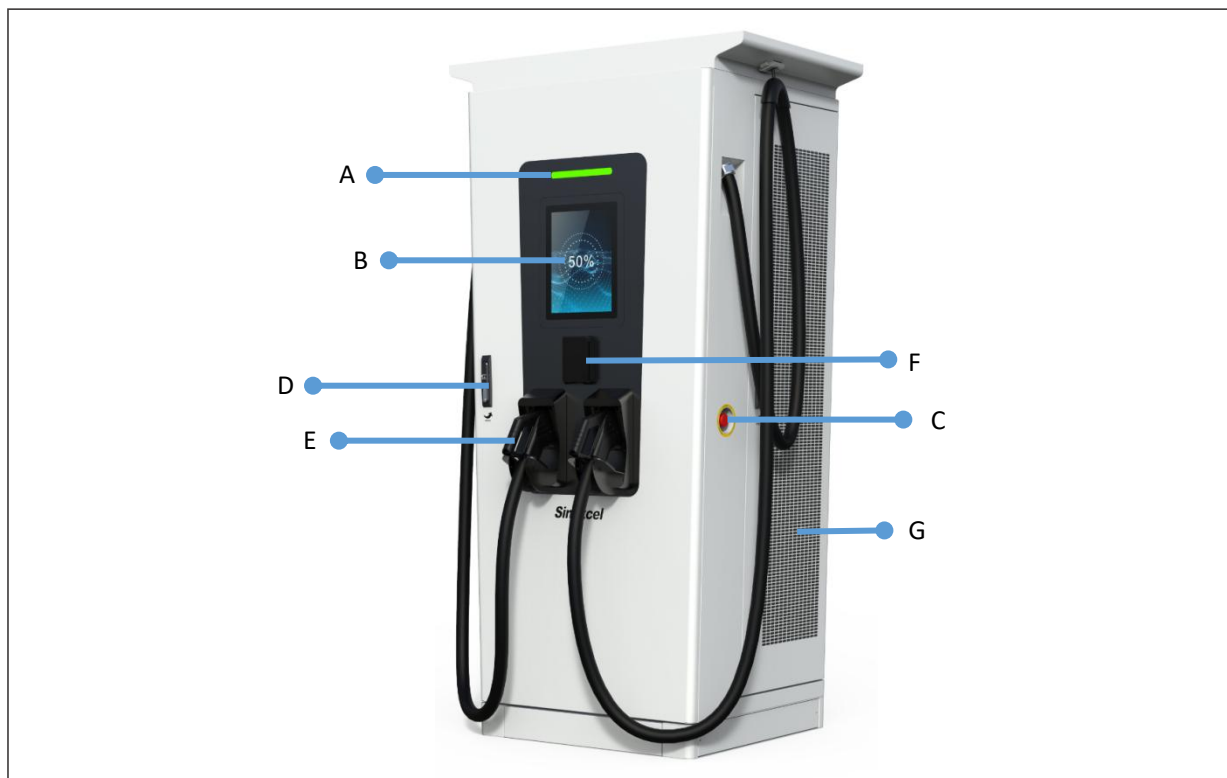

A	Status LED	E	Charging connector
B	Human machine interface	F	Pay card reader
C	Emergency button	G	Air outlet
D	Door handle/ lock		

2.5 Product characteristics

- A variety of power configurations from 160kW to 240kW can meet the customized requirements of customers. And more flexible power distribution, the dual connector model can automatically switch the power according to the vehicle demand, which can meet the rapid charging of two vehicles at the same time.
- The constant current and constant power charging methods have the advantages of high charging efficiency, simple operation and reliable performance.
- Ultra wide output voltage range, the highest output voltage can reach DC1000V. It can not only meet the low-voltage charging of small cars, but also meet the charging requirements of buses and high-voltage vehicles.
- User experience is highly considered by Sinexcel. Cable management system is optional in this charging system, which make it easier for the customer to charge and protect the cable. And the new 15 inches touchable screen can show more information about charging and show the advertisement.

- With overload, short circuit, leakage, lightning protection, overcharge, over voltage, under voltage, reverse connection, over temperature and other multiple protection functions.
- The intelligent standby mode can effectively reduce the operation cost of customers in the whole project life cycle, and improve the return rate of station charging.
- The cabinet shell is made of stainless steel with protection grade of NEMA3, which can be applied to various outdoor environments.

2.6 Parameter table of product specifications

Specification		
Category	Item	Parameter
Input Characteristic	Input	3P+N+PE
	Input Voltage	AC 480V±10%
	Frequency	50/60Hz
	Power Factor	0.99
	THDi	<5%
Output Characteristic	Output Voltage	CCS1 : 200-1000 Vdc HCCS1 : 200-1000Vdc JPN : 200-500Vdc
	Rated power	160-240kW
	Max Current	CCS1 : 200A HCCS1 : 300A JPN : 125A
	Peak Efficiency	95% @half load
Standards	System Standards	UL2231, UL2202
Others	Energy meter	High precision meter
	Number of connectors	1 connector: CCS combo 1 or HCCS combo 1 ; 2 connectors: CCS combo 1+JPN or CCS combo 1+ CCS combo 1 or HCCS combo 1+ HCCS combo 1 or HCCS combo 1+JPN
	Network Interface	4G/Wifi/LAN
	Size	W850*D750*H2000 mm
	Protection level	NEMA 3
	Gross Weight	≤600kg
	Net Weight	≤550kg
	Cable length	5m (Exposed cable length is 4.5m)
Communication protocol	OCPP1.6J	

Specification		
Category	Item	Parameter
	Display Screen	15 inches
	Method of payment	QR Code/RFID/NFC/Bank card (Optional)
	Language	English
Environmental conditions	Cooling method	Forced air cooling
	Full power operating temperature	-25 ~ 50 °C
	Humidity	5%~95%
	Altitude	≤2000m
Protection		DC Over current protection Surge Protection Device Emergency Stop Protection Overload protection Short circuit protection Electric leakage protection Overcharge protection Over voltage protection Under voltage protection Reverse connect protection Over temperature protection

3 Installation instructions

3.1 Equipment dimensions

1. The shape and dimension of the charger are shown in **Figure 3.1-A**.

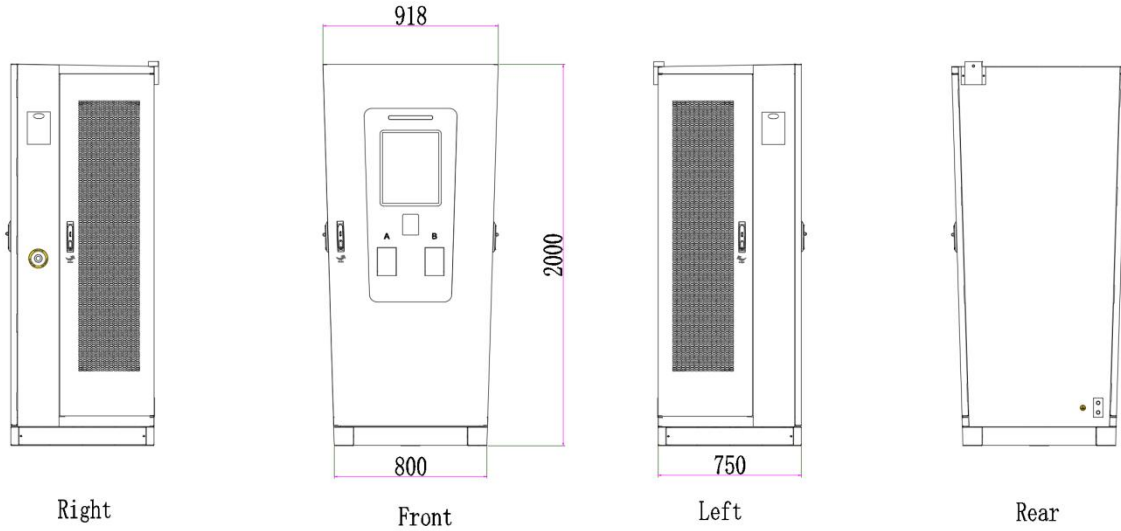

Figure 3.1-A Outline and dimension of charger

2. The hole size of charger base is shown in **Figure 3.1-B**.

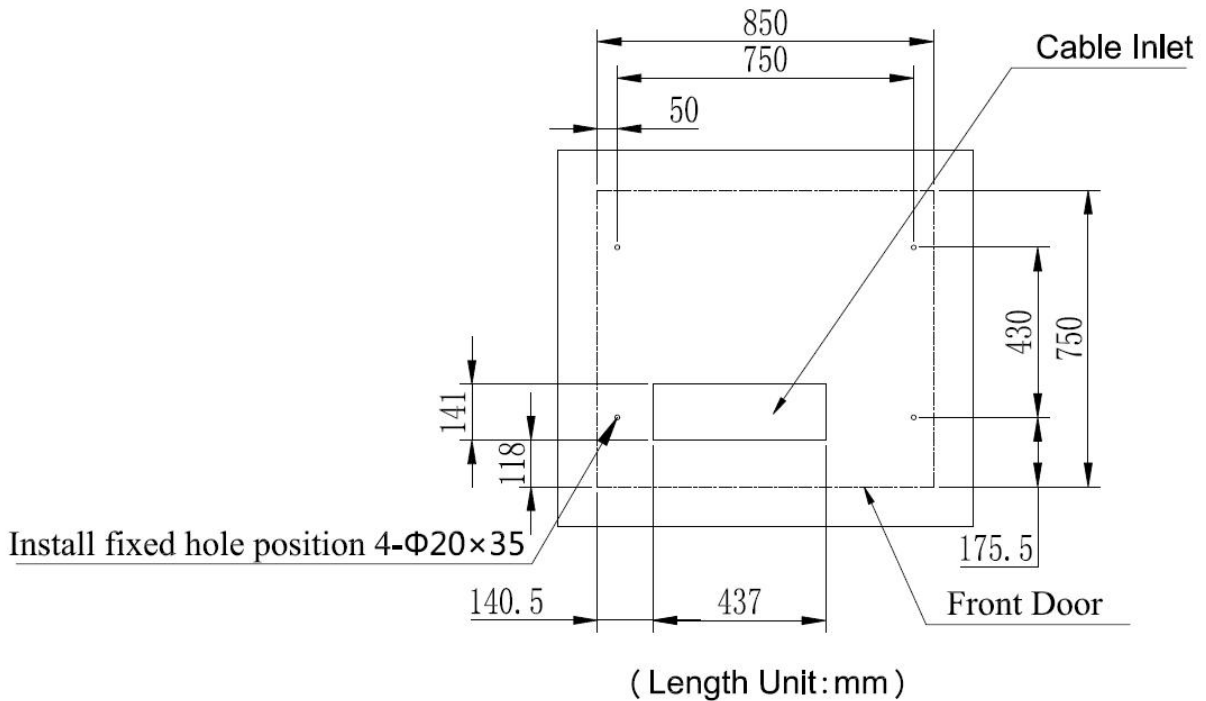

Figure 3.1-B Hole size of charger base

3.2 Equipment installation requirements

1. The charger is opened in front, left and right, and the connectors are used from both sides. Space should be reserved around. See **Figure 3.2-A** for the reserved size;
2. Installation on the foundation of channel steel or concrete; The cable shall be embedded in advance, the reserved length of Ethernet cable should not be less than 4000mm; the reserved length of control signal cable should not be less than 1500mm; the reserved length of power cable reserved shall be $700\text{ mm} \pm 20\text{ mm}$, and the protruding of the base through which 5 wires pass shall be less than 30 mm, as shown in **Figure 3.2-B**;
3. The height of the installation foundation is recommended to be $200\text{ mm} \pm 20\text{ mm}$, and the vertical inclination of the installation shall not exceed 5° . See **Figure 3.2-B** for details;
4. Install 4 stainless steel M12 * 80mm expansion bolts between the base and the cabinet. Note that the bolts need to be equipped with M12 stainless steel flat gasket.

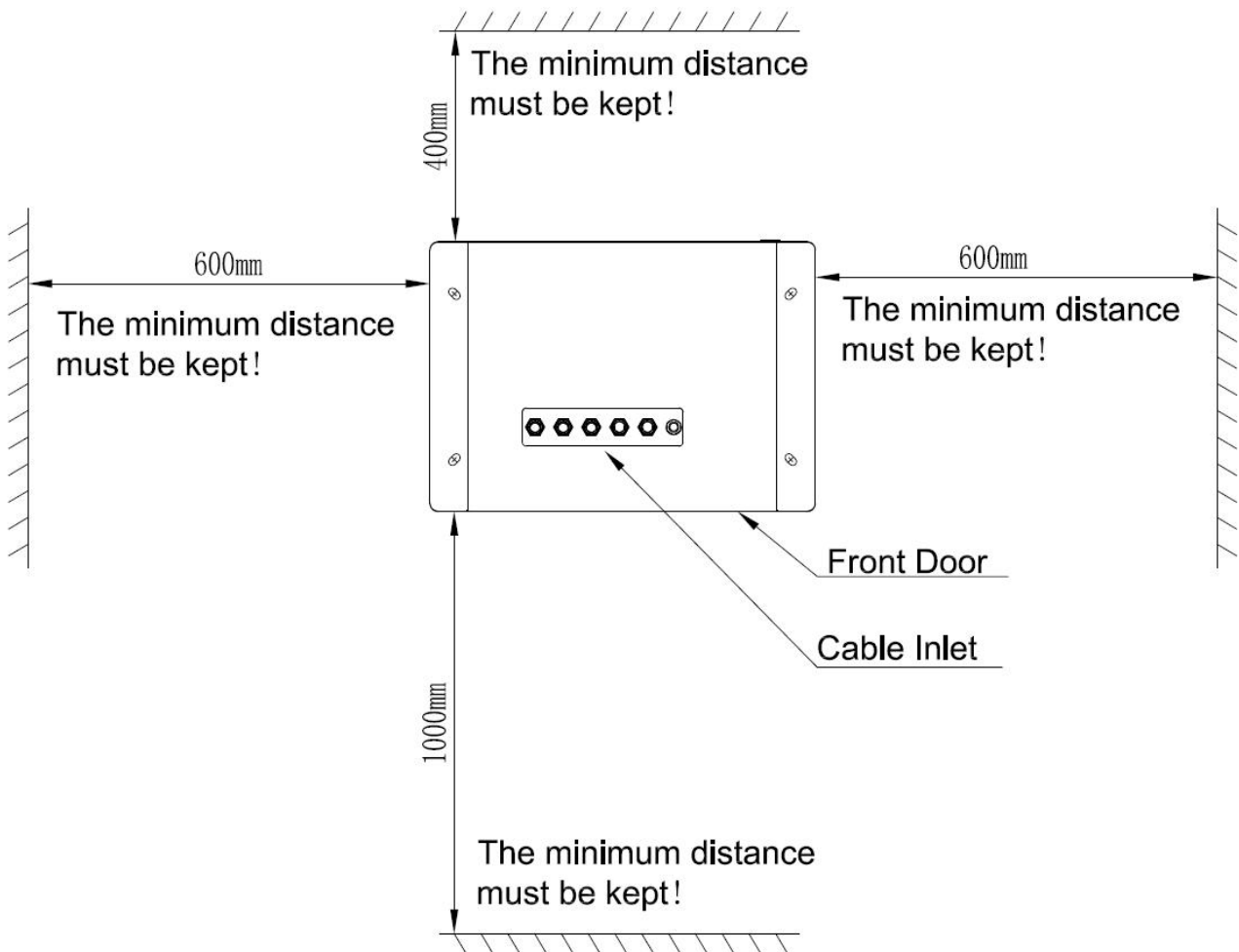

Figure 3.2-A Requirements for charger placement

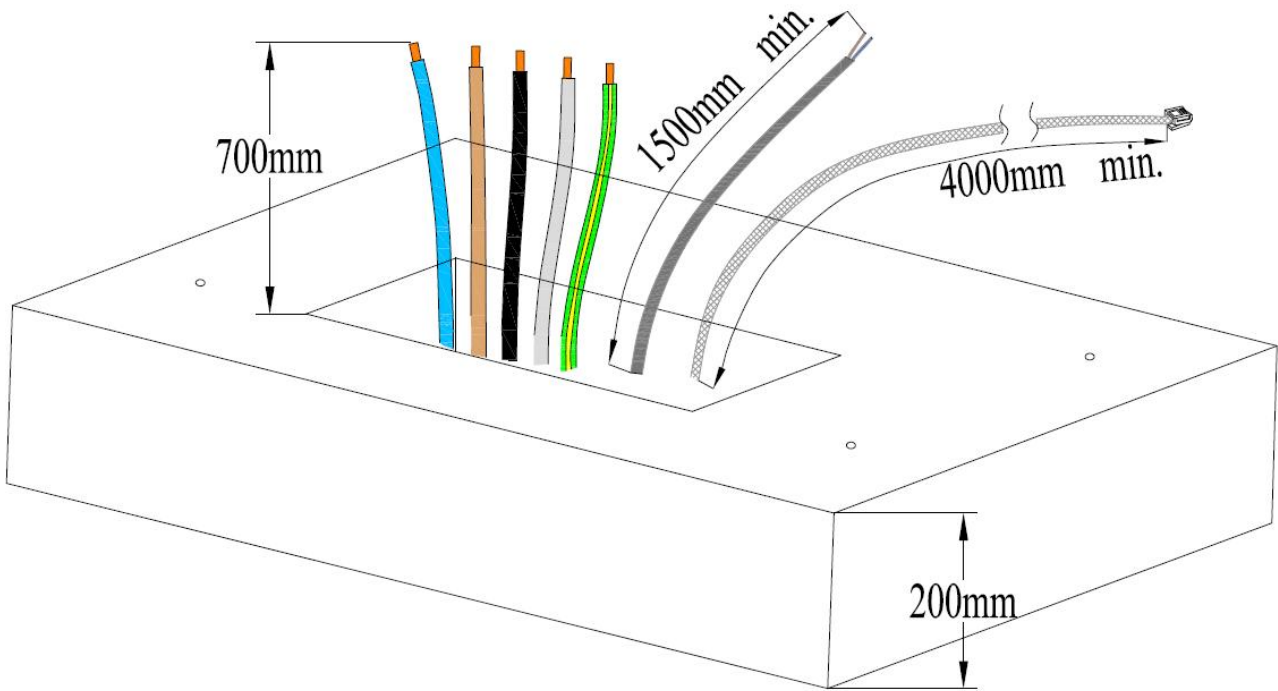

Figure 3.2-B Base and cable reservation requirements

3.3 Construction of distribution cables

3.3.1 Layout requirements of distribution cables

1. The input cable of the system is introduced from the inlet hole at the bottom of the charger, and the cable shall be laid through the cable trench.
2. The AC cable adopts copper core wire, and the cross-sectional area of the cable shall adapt to the load.
3. The outdoor power cable shall be laid according to the power specification. The power cable and the signal cable must be separated, and the signal cable should be put through the tube separately to avoid the pressure loss and interference of the communication signal.
4. The cable shall not be laid in the area easily damaged by mechanical damage, corrosive medium emission, humidity, strong magnetic field and strong electrostatic field interference. If necessary, please take corresponding protection or shielding measures.
5. The AC input cable starts from the user's distribution switch and connects to the copper bar of the charger's inlet cable switch. Protection devices shall be provided at the user's power distribution.
6. The color of AC input cable is brown (L1), black (L2), gray (L3), blue (N), yellow green (PE). If the input cable has only one color, it is necessary to paste cable number identification (or tube with mark).

3.3.2 Process requirements of distribution cables

1. Cable laying shall be free from external force, distortion and damage of insulation layer.
2. It is strictly forbidden to twist, flatten, break the protective layer and wear the protective layer seriously.
3. The protective pipe shall be cleaned before the cable passes through the pipe, and the wire shall not be damaged.
4. The cable arrangement shall be tidy. The binding should be neat and should not be crossed.
5. Sufficient allowance shall be reserved for each wire of the cable, and the bending degree shall be consistent.
6. Crimp the terminal of the cable head, and there should be no gap on the penetration surface of the terminal after crimping.
7. When pressing the lug of inlet cable, the heat shrinkable tube should be set between the cable and the lug, and the inside and outside of the tube should be smooth without damage and crack. Before setting the heat shrinkable tube, the sundries on the cable shall be removed, and there shall be no burr and iron filings on the surface to prevent damage to the tube. The color of the tube shall be in accordance with the phase sequence. When the tube is heat shrinkable, the flame should be avoided to spray on the inside of the cabinet to prevent burning the internal components and cables of the cabinet. The appearance of heat shrinkable casing should be flat, smooth, uniform shrinkage, no dust and crack.
8. Attention should be paid to the wiring sequence when pressing RJ45 connector for Ethernet cable. Check whether the pressing is qualified after pressing.

3.3.3 Cable specifications for AC input (Recommended)

Capacity (kW)	Cable specification (Copper cable)	Capacity of superior distribution switch	Screw specification (diameter: mm)	Cable terminal
160kW	4*185mm ² +1*95mm ²	400A	L1/L2/L3/ N: M16 PE: M12	L1/L2/L3/ N: DT185-16 PE:DT95-12
180 kW &200 kW	4*240mm ² +1*95mm ²	500A	L1/L2/L3/ N: M16 PE: M12	L1/L2/L3/N: DT185-16 PE:DT95-12
240kW	4*300mm ² +1*120mm ²	630A	L1/L2/L3/ N: M16 PE: M12	L1/L2/L3/N: DT240-16 PE:DT120-12

3.3.4 Internal wiring diagram of equipment

The internal input cables are N, L1, L2, L3, PE, Ctrl and Eth from left to right. The 'Ctrl' indicates a control signal cable and the 'Eth' indicates a Ethernet cable .The cabinet grounding is divided into two parts, one is the grounding bar inside the cabinet, and the other is the grounding of cabinet shell, as shown in **Figure 3.4-A**.

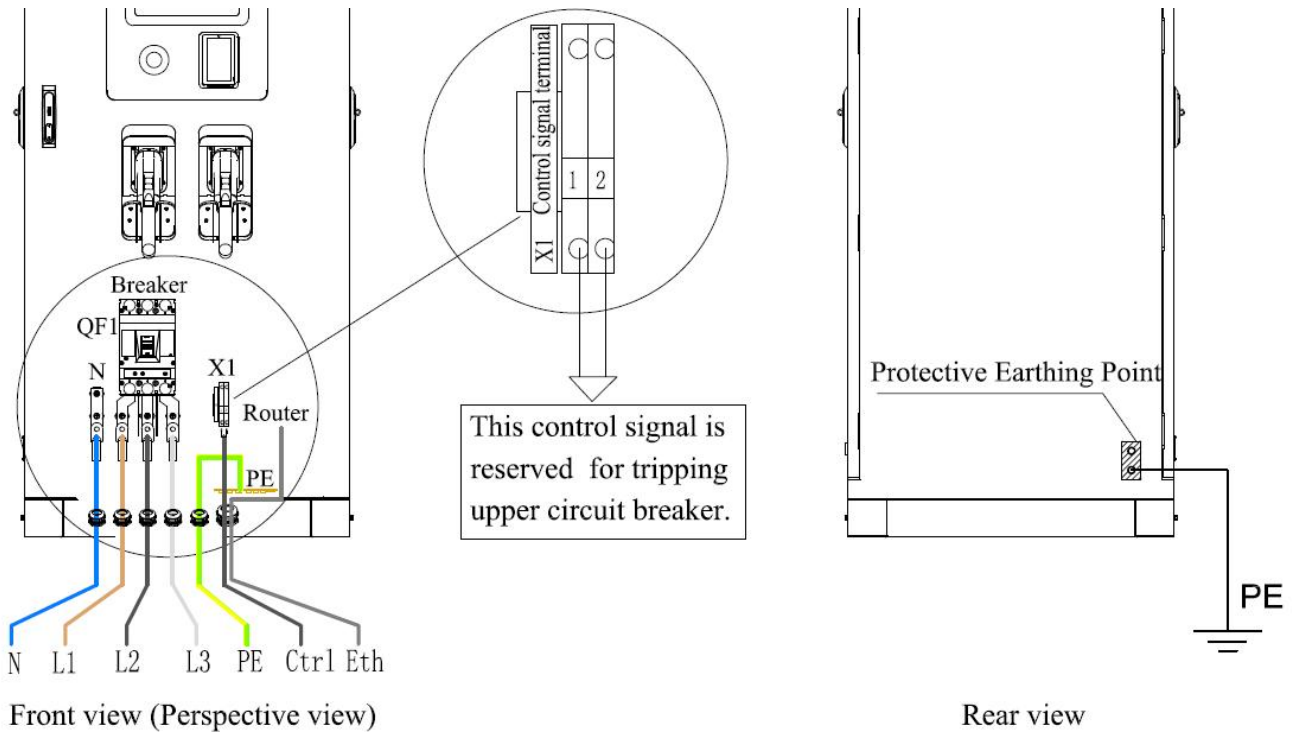

Figure 3.4-A Internal wiring diagram of charger

3.4 Inspection after installation

Stability

After the pile is installed, shake the cabinet from different directions, and there should be no obvious loosening and shaking.

Clean up

- Dispose of all transportation and packaging materials in accordance with local regulations.
- Clean up the sundries inside and around the cabinet, such as small section of cable, binding tape, screw / nut, desiccant, etc. Do not leave installation tools on site or in the cabinet (record the type and quantity of tools to prevent omission).
- Wipe the insulation with anti-static cloth. Do not use any corrosive solvent.
- 4. Inspection
- Check whether the base is fixed and sealed.
- Check whether the internal components of the equipment are tight and reliable.
- Check whether the electrical connection and wiring are correct and complete, whether the connection is reliable, and whether the grounding is reliable.
- Check whether the cable terminal is loose, and calibrate the screw fixing the terminal.
- Check whether the cable is broken, damaged and scratched.
- Check whether the protection level of the equipment meets the requirements, especially the cable entrance at the bottom of the pile.
- Check appearance, marking, integrity, cleanliness.
- Check the installation of the equipment according to the foundation installation drawing.

3.5 Special version

After charging, the charging connectors need to be placed on the retracting device, as shown in **Figure 3.5**



Figure 3.5

4 Operation interface

4.1 Charging process

Note: when the charger is in standby mode, the screen is in the energy-saving mode. Before operation, touch the screen with your finger to light up the screen! The screen has been split, which can be used for advertising below the operation interface.

4.1.1 Standby interface

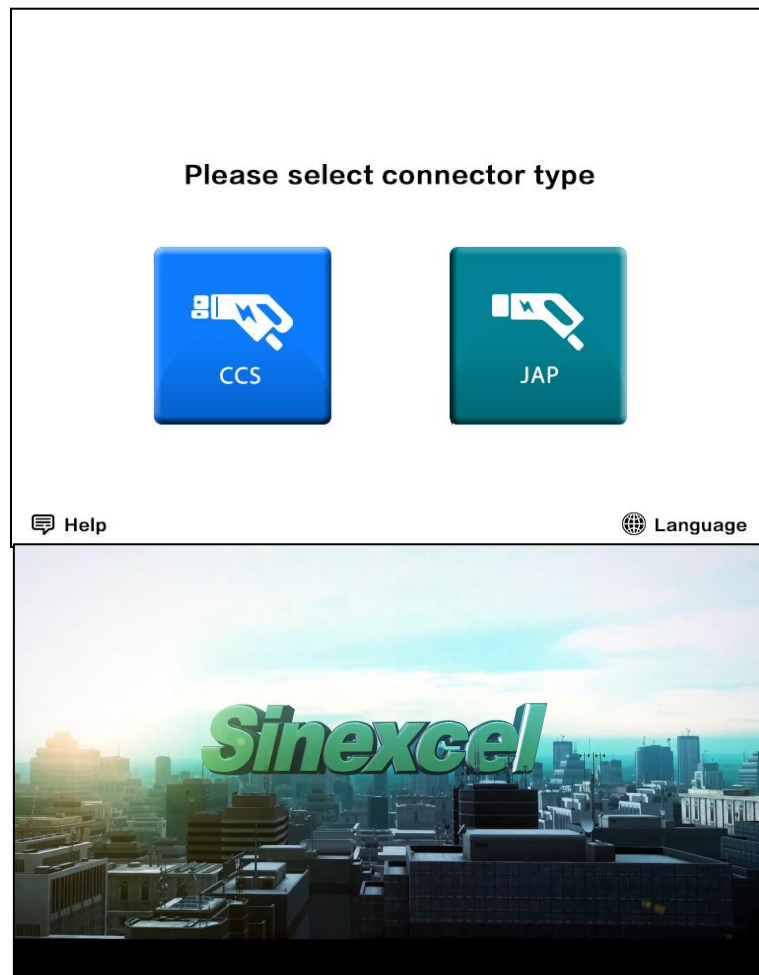

Tip:

1. Select CCS connector or JPN connector according to the socket type of the car. The following is the process of selecting CCS, and the JPN steps are consistent with CCS.

2. Click “language” in any interface to switch the language mode of the UI. At present, Chinese, English and Korean are supported.

4.1.2 Waiting for connector insertion interface

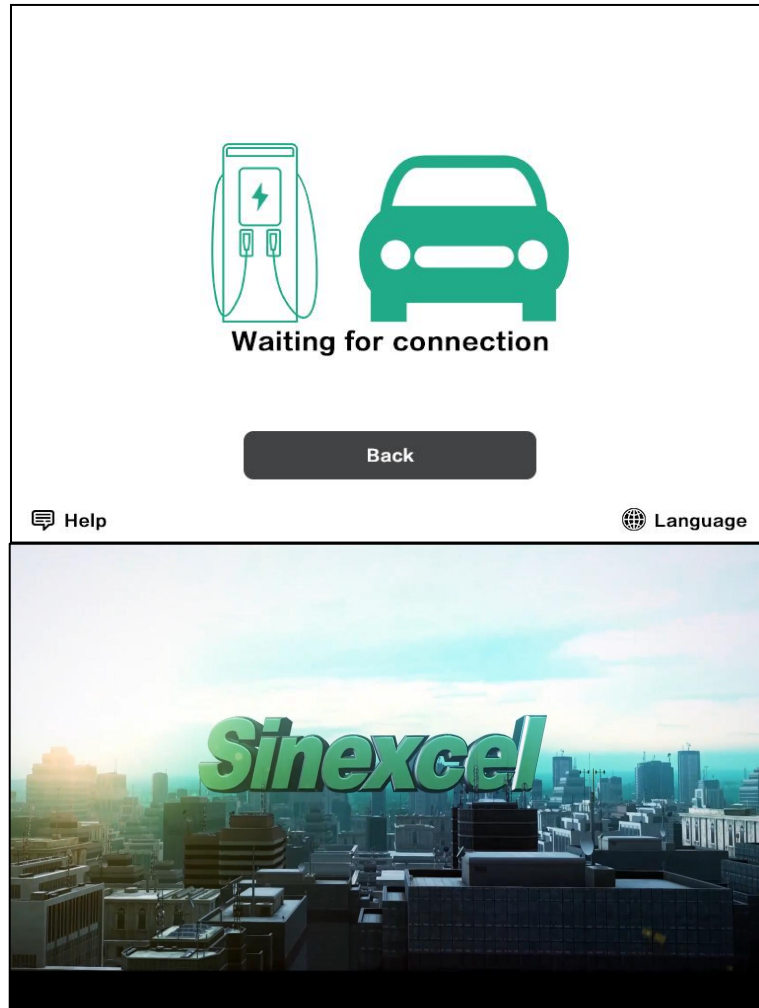

Tip: connecting the connector to the car will jump to the connector insertion interface.

4.1.3 Connecting interface

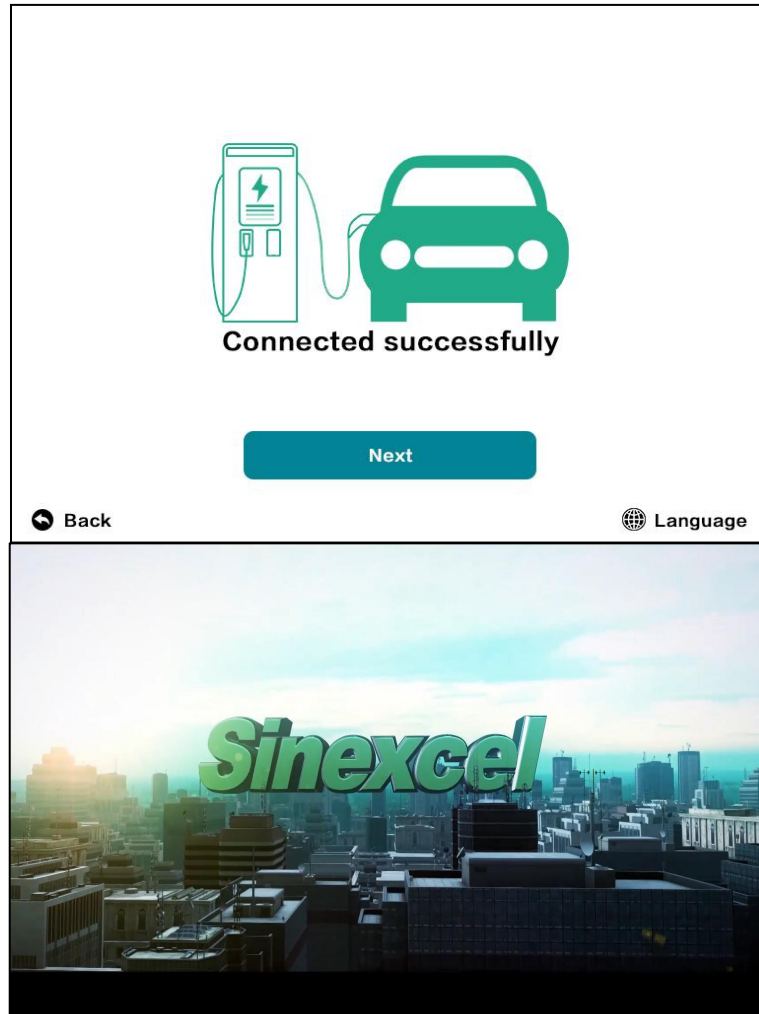

Prompt: click next to enter the interface of charging mode selection.

4.1.4 Select charging mode interface

Notice: click the payment method you want to enter the next charging operation.

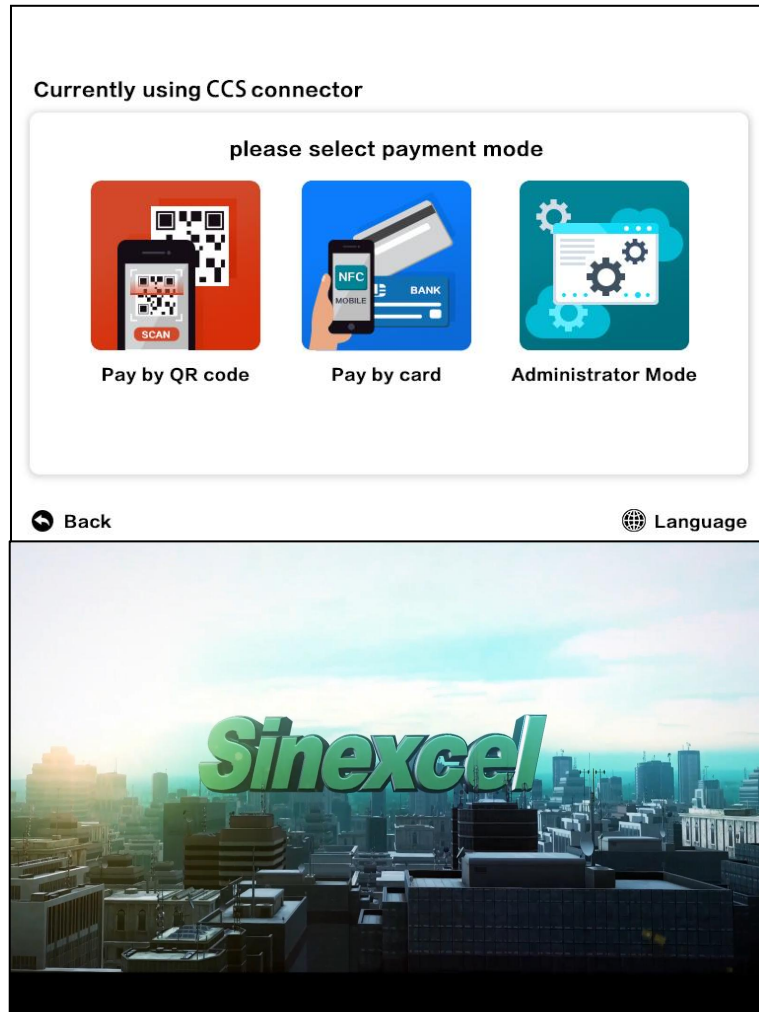

Code scanning charging interface process

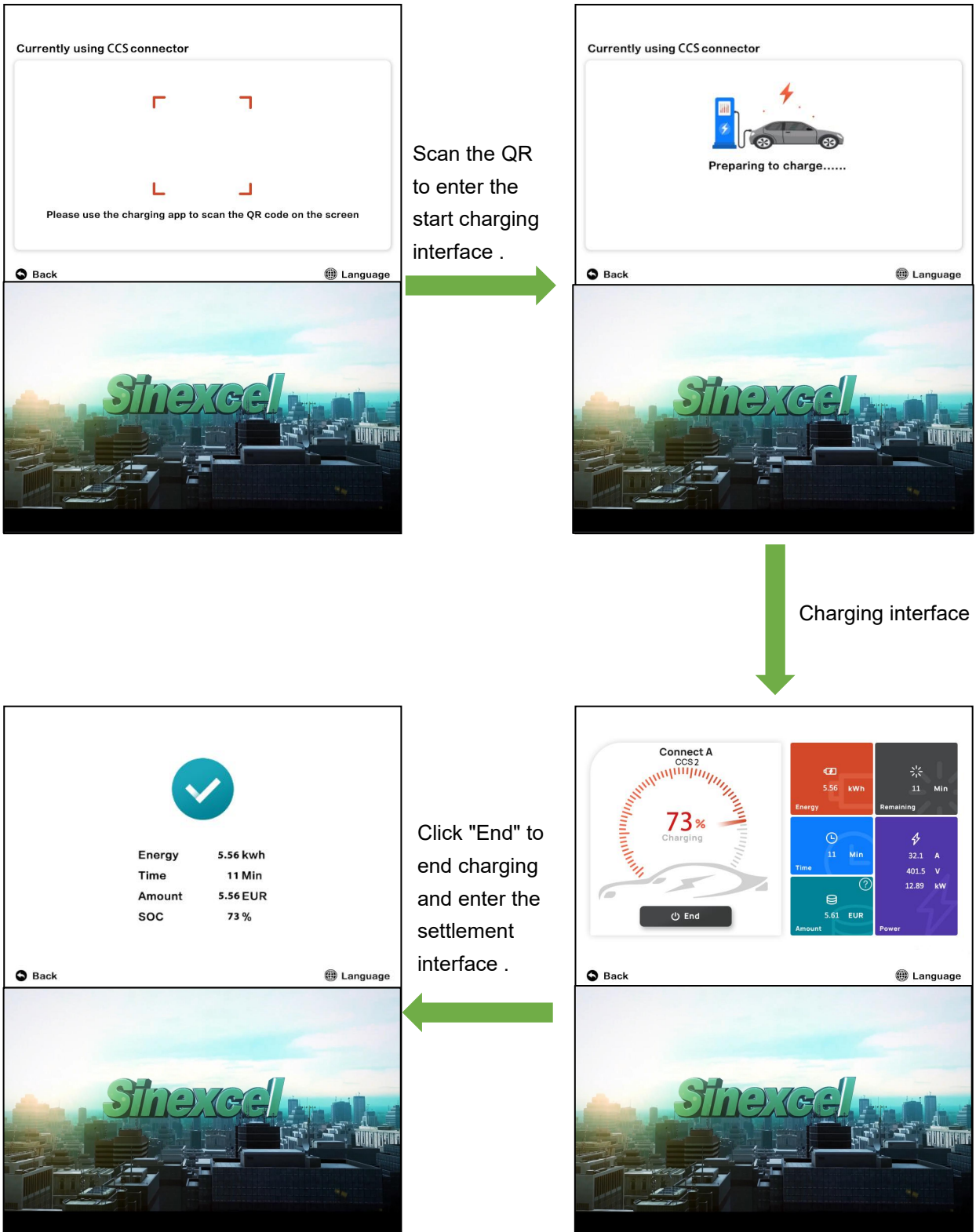

Tip: after charging, click back. If the other charging connector is in charging state, it will jump to the charging interface of the other charging connector, otherwise it will jump to the main interface.

Interface process of pay by card charging

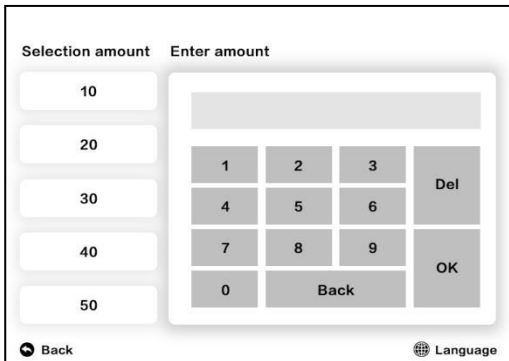

Select or enter the precharge amount to enter the card swiping interface.

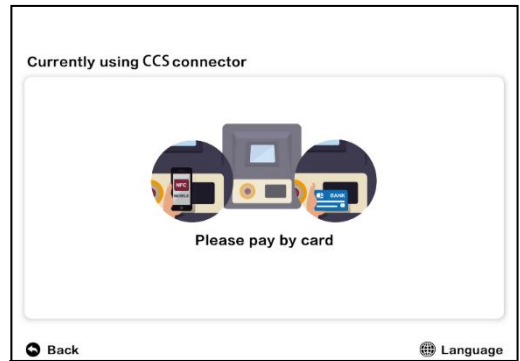

Pay by card according to the interface prompt to enter the charging start interface.

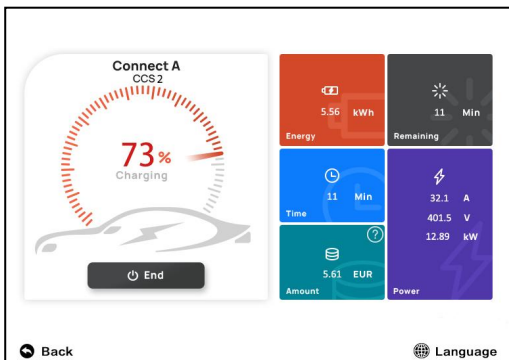

Charging interface.

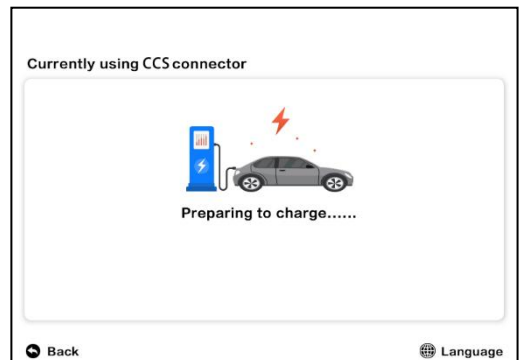



Click "End" to end charging and enter the pay by card interface.

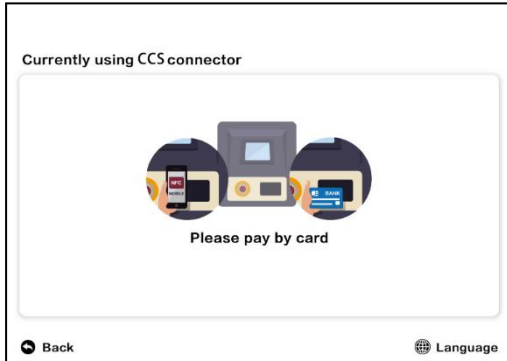

Enter the settlement interface after paying by card according to the interface



Password charging interface process



Enter the password to enter the start charging interface.



Charging interface.

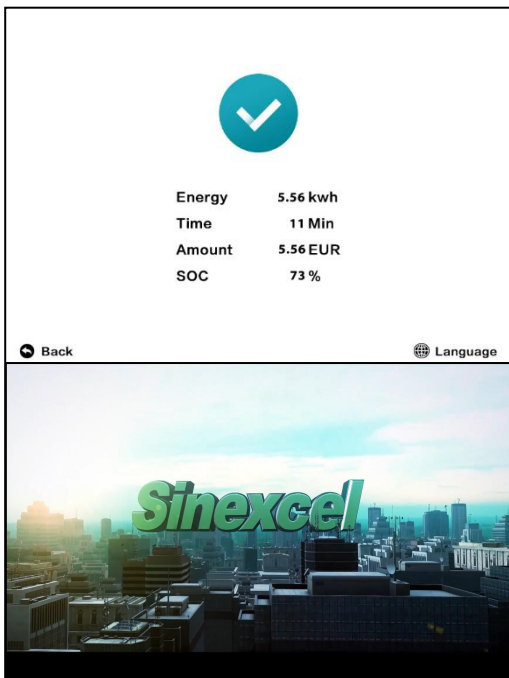

Click "End" to end charging and enter the pay interface.



Tip: click the input box to pop up a small keyboard. Enter the complete password through the keyboard and click OK to verify the password. After passing the verification, it will jump to the password start charging interface (password setting: administrator > Settings > MCU > function > offline charging password).

5 Simple troubleshooting

Analysis and treatment of common faults

Refer to the maintenance manual for detailed treatment

Error code	Name of alarm or fault	Processing method
7	Lightning protection failure	<ul style="list-style-type: none"> ● Check the status of lightning arrested. If the visual window of lightning protection is red, it means it is damaged, please replace it.
1	Emergency stop fault	<ul style="list-style-type: none"> ● Please check whether the emergency stop button is pressed and not pulled out. If the fault has been solved, please pull up the emergency stop button.
11	Over temperature protection of air outlet	<ul style="list-style-type: none"> ● Please check whether the air duct of the system is blocked and whether there is too much dust on the dust screen. ● Please check whether the air outlet fan of charger works normally. If the fan fails, please replace the fan.
32	Access protection	<ul style="list-style-type: none"> ● Please check whether the cabinet door is completely closed; ● Confirm that the door is closed, but the alarm still appears. Please check the status of the micro switch. If it is damaged, please replace it.
20	Charging module failure	<ul style="list-style-type: none"> ● Check the module fault code, confirm the fault type and find the fault cause. ● Pull out the fault module and replace the spare module. ● Check whether the alarm light of RCD device is on. If the lamp is on, it indicates that the system has leakage fault,
3	RCD action	<ul style="list-style-type: none"> ● It is necessary to check whether there is insulation fault in the circuit at the back end of RCD; ● Check whether the casing is reliably grounded.



Notice: in order to prevent personal electric shock accident, all switches of the equipment and front-end power distribution switch of the equipment shall be disconnected during fault detection and treatment, and protective measures shall be taken.

6 After-sales service

If you have any questions or questions, please contact the equipment supplier.

Before contacting the equipment supplier:

- Please check the troubleshooting measures in the chapter "5. Simple troubleshooting".
- Please record the model and serial number of the equipment (name plate of the equipment) and the failure time.